Industrias W de
México.



Industrias W de Mexico is a subsidiary of CSE Global Limited "Technology and Services for the Energy Industry".

Provides integration and manufacture of automation and control systems, fire and gas systems and electrical and instrumentation (E&I) construction.

Our goal is to meet the needs of the public and private sector. Mainly offering integrated services to the oil and gas sector. Our team has extensive experience in maintenance, fabrication, acquisition & Commercial Diving, including rescue recovery. We also provide transportation services, logistics, marine & tool rental equipment.



THE FOLLOWING OFFERS

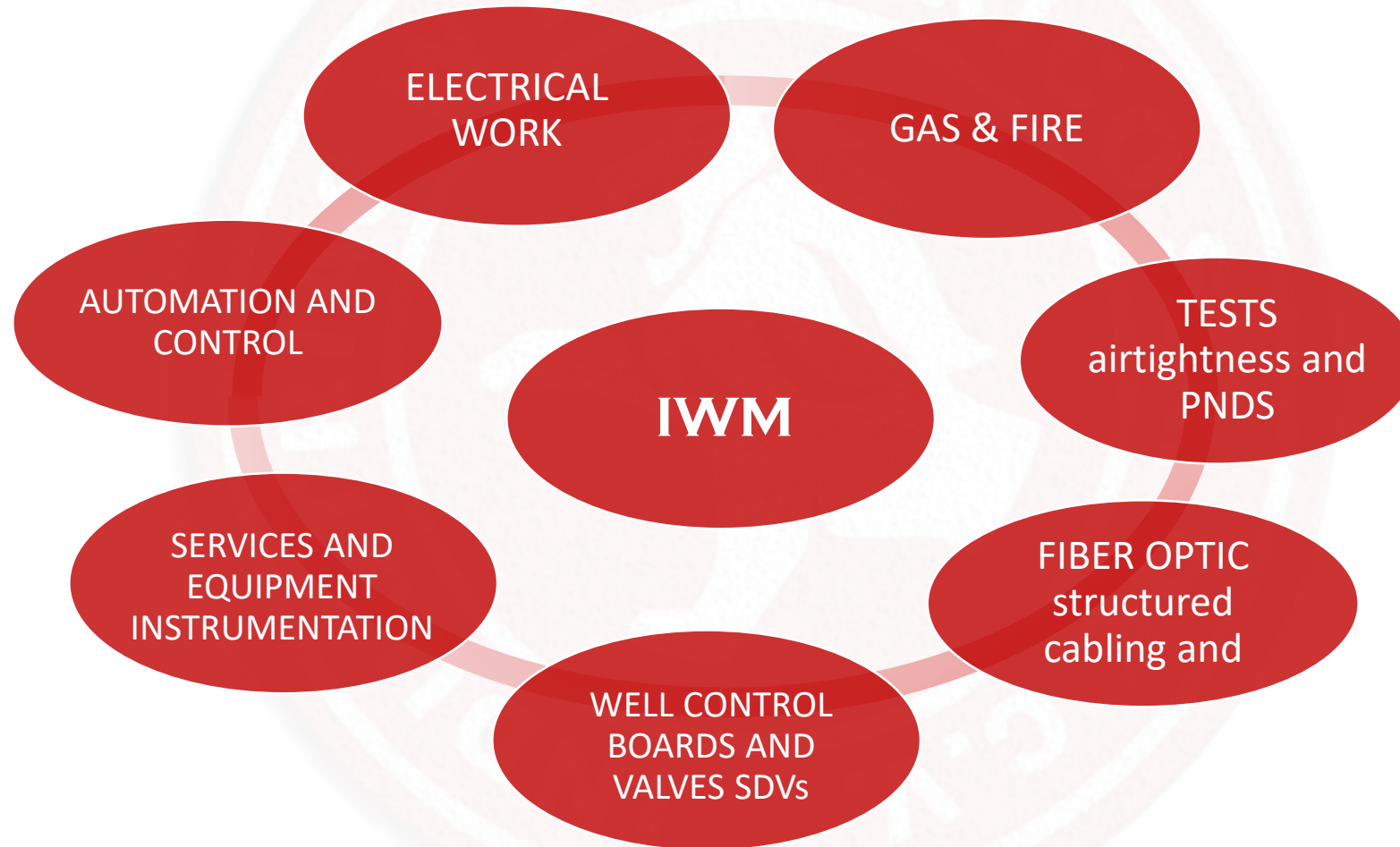

Certifications

QAC
Quality Alliance Certification
Alianza para tu Certificación

Certificado No. QAC130023

QAC, Certificación, S.A. de C.V. certifica que:

INDUSTRIAS W DE MÉXICO, S.A. DE C.V.

Ubicado en: Avenida del Mar No. 46, Colonia Bibalvo, Ciudad del Carmen, Campeche, CP 24158.

Ha establecido y mantiene un Sistema de Gestión de la Calidad con base a la Norma:

**NMX-CC-9001-IMNC-2015
ISO 9001:2015**

El alcance de la certificación aplica a:

"Integración, mantenimiento y fabricación de sistemas de control; así como servicios de mantenimiento y construcción eléctrica e instrumentación"

Emitido: 04/02/2017
Vigencia: 3 años
Expiración: 03/02/2020
Edición No: 01

IAF **ema**
entidad mexicana de acreditación, s.c.
Acreditación No. 7613
Fecha de Acreditación: 05/02/2016

JEFE DE CERTIFICACIÓN

La validez de este certificado esta sujeta a la apropiada aplicación y mantenimiento del Sistema de Gestión de la Organización, de conformidad con los requerimientos establecidos en la normativa de referencia. La auditoría será monitorizada por QAC, Certificación, S.A. de C.V.

EL PRESENTE DOCUMENTO ES VALIDO SOLO SI SE ASUNTAN LOS DISTINGUIMIENTOS DE LOS SEGUIMIENTOS, REALIZADOS POR QAC, CERTIFICACIÓN, DURANTE EL PERIODO DE VIGENCIA DEL CERTIFICADO.

QAC, Certificación, S.A. de C.V.
Avenida Veracruzatipet No. 381, Colonia Agua Azul, Sección A, Municipio de Mexpanhikuyel, Estado de Mérida, C.P. 97500
www.certificaciodominico.com.mx

FO-CER-04 Rev. 01

QAC
Quality Alliance Certification
Alianza para tu Certificación

Certificado No. QAC-2017-0025/01

QAC, Certificación, S.A. de C.V. certifica que:

INDUSTRIAS W DE MÉXICO, S.A. DE C.V.

Ubicado en: Avenida del Mar No. 46, Colonia Bibalvo, Ciudad del Carmen, Campeche, CP 24158.

Ha establecido y mantiene un Sistema de Gestión de Seguridad y Salud en el Trabajo con base a la Norma:

NMX-SAST-001-IMNC-2008

El alcance de la certificación aplica a:

"La realización de actividades de obra eléctrica para la integración, mantenimiento y fabricación de sistemas de control; así como servicios de mantenimiento y construcción eléctrica e instrumentación"

Emitido: 13/02/2017
Vigencia: 3 años
Expiración: 13/02/2020
Edición No: 01

IAF **ema**
entidad mexicana de acreditación, s.c.
Acreditación No. 7613
Fecha de Acreditación: 05/02/2016

DIRECTOR GENERAL

La validez de este certificado esta sujeta a la apropiada aplicación y mantenimiento del Sistema de Gestión de la Organización, de conformidad con los requerimientos establecidos en la normativa de referencia. La auditoría será monitorizada por QAC, Certificación, S.A. de C.V.

EL PRESENTE DOCUMENTO ES VALIDO SOLO SI SE ASUNTAN LOS DISTINGUIMIENTOS DE LOS SEGUIMIENTOS, REALIZADOS POR QAC, CERTIFICACIÓN, DURANTE EL PERIODO DE VIGENCIA DEL CERTIFICADO.

QAC, Certificación, S.A. de C.V.
Avenida Veracruzatipet No. 381, Colonia Agua Azul, Sección A, Municipio de Mexpanhikuyel, Estado de Mérida, C.P. 97500
www.certificaciodominico.com.mx

FO-CER-08 Rev. 01

QAC
Quality Alliance Certification
Alianza para tu Certificación

Certificado No. QAC-2017-0021/01

QAC, Certificación, S.A. de C.V. certifica que:

INDUSTRIAS W DE MÉXICO, S.A. DE C.V.

Ubicado en: Avenida. del Mar No. 46, Colonia Bibalvo, Ciudad. del Carmen, Campeche, CP 24158.

Ha establecido y mantiene un Sistema de Gestión Ambiental con base a la Norma:

**NMX-SAA-14001-IMNC-2004
ISO 14001:2004**

El alcance de la certificación aplica a:

"La realización de actividades de obra eléctrica para la integración, mantenimiento y fabricación de sistemas de control; así como servicios de mantenimiento y construcción eléctrica e instrumentación"

Emitido: 13/02/2017
Vigencia: 3 años
Expiración: 13/02/2020
Edición No: 01

IAF **ema**
entidad mexicana de acreditación, s.c.
Acreditación No. 7613
Fecha de Acreditación: 05/02/2016

DIRECTOR GENERAL

La validez de este certificado esta sujeta a la apropiada aplicación y mantenimiento del Sistema de Gestión de la Organización, de conformidad con los requerimientos establecidos en la normativa de referencia. La auditoría será monitorizada por QAC, Certificación, S.A. de C.V.

EL PRESENTE DOCUMENTO ES VALIDO SOLO SI SE ASUNTAN LOS DISTINGUIMIENTOS DE LOS SEGUIMIENTOS, REALIZADOS POR QAC, CERTIFICACIÓN, DURANTE EL PERIODO DE VIGENCIA DEL CERTIFICADO.

QAC, Certificación, S.A. de C.V.
Avenida Veracruzatipet No. 381, Colonia Agua Azul, Sección A, Municipio de Mexpanhikuyel, Estado de Mérida, C.P. 97500
www.certificaciodominico.com.mx



Dashboards wells and valves SDVs

INDUSTRIAS W DE MEXICO SA DE CV, It has designed, manufactured, transported, installed and put into operation in many boards PEMEX platforms, among which include the following:

- | | |
|-----------|---------------|
| MALOOB-A | • BALONTIKU-B |
| MALOOB-B | • LA KAHUASA |
| PP-KU-C | • BAGRE-C |
| PP-KU-S | • MISON-A |
| PP-ZAAP-A | • PP-LUM-A |
| PP-B-ZAAP | • AKA-Q |
| PP-ZAAP-D | • SIHIL-A |
| SINAN-A | • KAX-A |
| SINAN-B | • KUIL-A |
| SINAN-C | • AYATSYL-B |
| SINAN-D | • K-H |
| SINAN-SO | • K-F |
| MAY-C | |



Well Control Board Service.



Security Control Systems And Instrumentation



Hydraulics Power Units

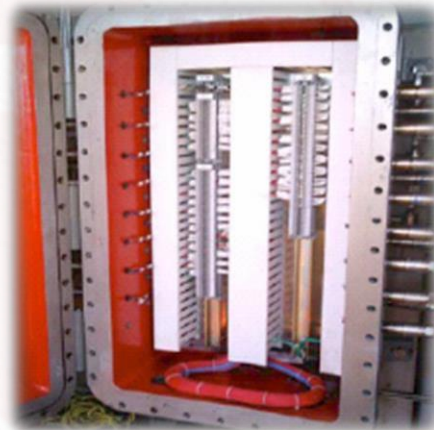

UPR Emergency shutdown System.



Interface Board



Instrument Rack

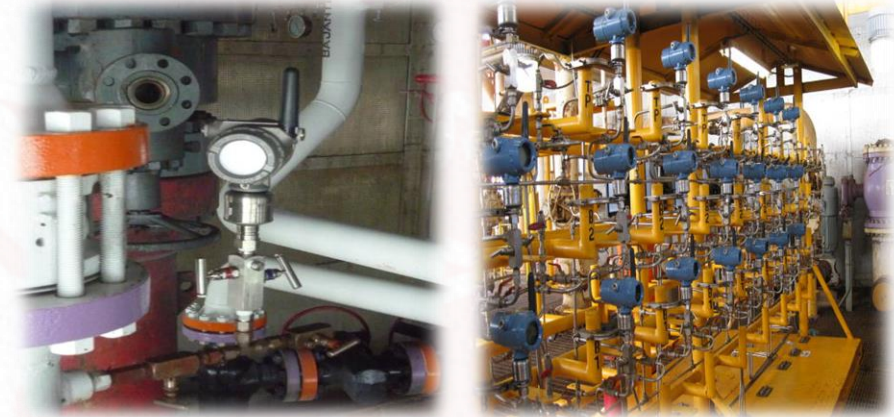
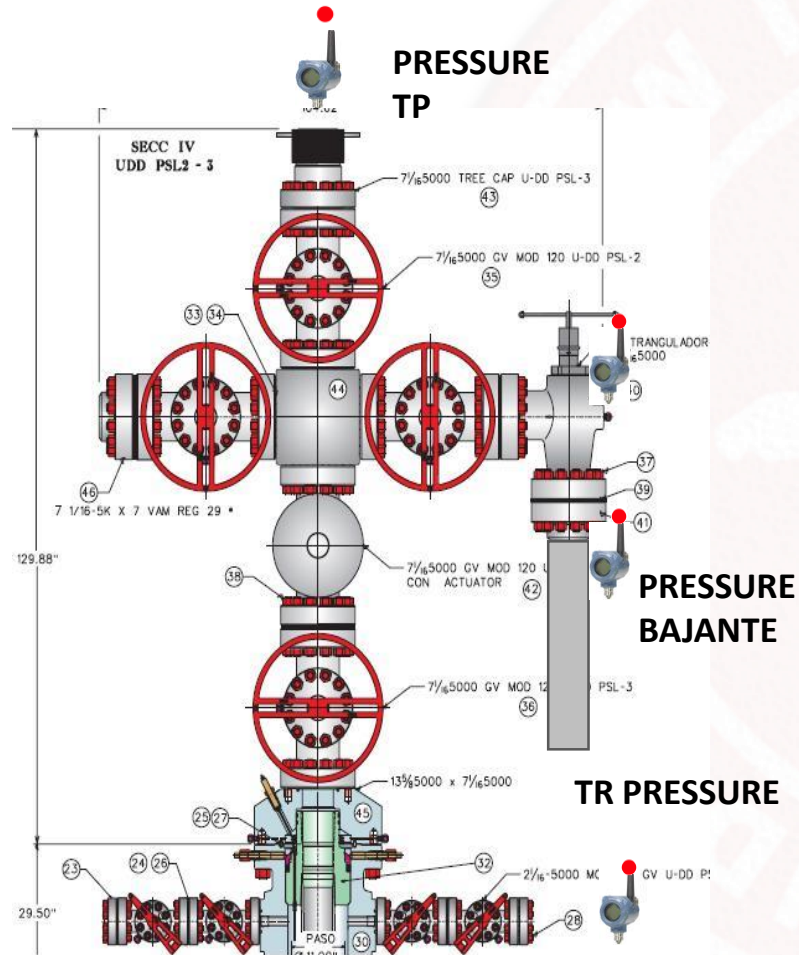

- Process pressure measurement
- Pressure TP, TR and downspouts in wells
- Pressure BN Network, Arrivals Y Departures.
- Pressure of suction Y discharge of pumps



Monitoring Variables



monitoring of Pressure in downspouts of wells. Caan A, Abkatun Pol Chuc



monitoring of Pressure oil-gas pipeline toward Akal - C., Akal-BN, Cantarell



Automation of taking of readings of Pressure in different points Installation.



monitoring TP and TR in wells. Ixtal-A, Abkatun Pol Chuc



monitoring of Pressure entry separator Pivot Akal GP, Cantarell



monitoring of the Pressure of the supply Hydraulic Console Baker, Chuc B, Abkatun Pol Chuc

Well Control Boards Maintenance Service .

- master section board.
- Section control modules.
- Section bypass.
- General cleaning.
- Maintaining internal tubing.
- Replacement tubing interconnection field.
- Testing and calibration of different shooting points.



Industrias W is the main supplier in Mexico of Well Control Panels, and collaborator for the elaboration of the normative P.2.022.01-2015, "Well Control Panels".



Instrumentation Services & Equipment

- Installation, maintenance and calibration of field instrumentation. **In HART protocols Fundation Field Bus.**
- Calibration equipment traceable to standard.
- Review, diagnosis and maintenance of industrial instrumentation and F & G systems.
- Pre-commissioning Y commissioning industrial instrumentation and systems F & G ..



Installation, maintenance, calibration and testing valves:



- Emergency shutdown valves SDV.
- Control valves and regulators.
- Safety valves
- Fire valves



Activities undertaken teams as Testing Bank, Adjustment, Calibration, Diagnostics and Troubleshooting Fault. For this we have diagnostic tools such as shapers 475 Hart Field, AMS Valve Link



Automation and control

Design, engineering, construction, operation and maintenance of automation and control systems

- Engineering development and architecture of monitoring and control systems
- Signal integration packages SDMC equipment (brand: Honeywell, Rockwell, Invensys)
- HMI and PLC programming `s (Brand: Rockwell, Schneider, Siemens).

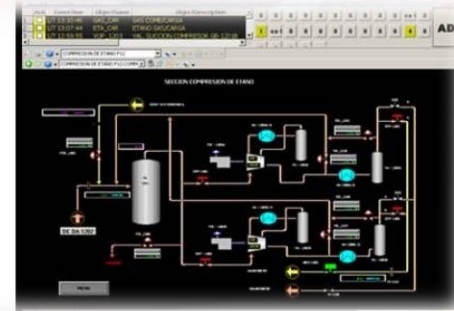
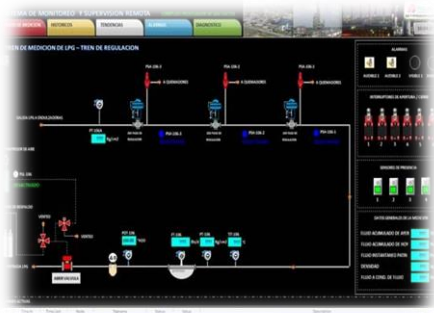

Gas & Fire

- Gas & Fire Safety
- Design, engineering, integration and installation of systems
- Platform sound and cctv
- Testing
- Training
- Preventive, corrective maintenance and general repairs to the firefighting network system and its components:
 1. Motor pump
 2. Electric pump
 3. Deep well pump
 4. Hydraulic network
 5. Valves and monitors



- Calibration of the following detectors:
 - **Fuel gas.**
 - **H2S**



Measurement of Liquid and Gas flow:

- Hydrocarbon measurement system for custody transfer
- Integration, installation of metering skids
- Programming, diagnostics of flow computers
- Maintenance of flow measurement systems and elements
- Installation, calibration meter type:
 - ultrasonic (hydrocarbons in liquid and gaseous phase)
 - turbine (gas and liquid hydrocarbon phase)
 - magnetic



Electrical Work

- Installation and interconnection control room
- Low voltage electrical systems
- Industrial electrical installations
- System of put to Earth
- Lightning rods systems
- UPS uninterruptible power systems



Electrical Studies

- Short analysis
- Protection Coordination
- Load flow
- Harmonic Analysis
- Voltage Regulation
- Lightning protection
- Power Factor Study
- Energy saving study



Tightness Testing and PNDs

- Lines newly manufactured
- Valves
- Containers.
- Welds revision.
- Opinions integrity.
- Energized equipment service and / or lines of process.



Voice and Data

- Experience of integrating access control system in housing platforms and facilities on land, complying with the requirements of the integral access control, assistance and surveillance system (conaavi)

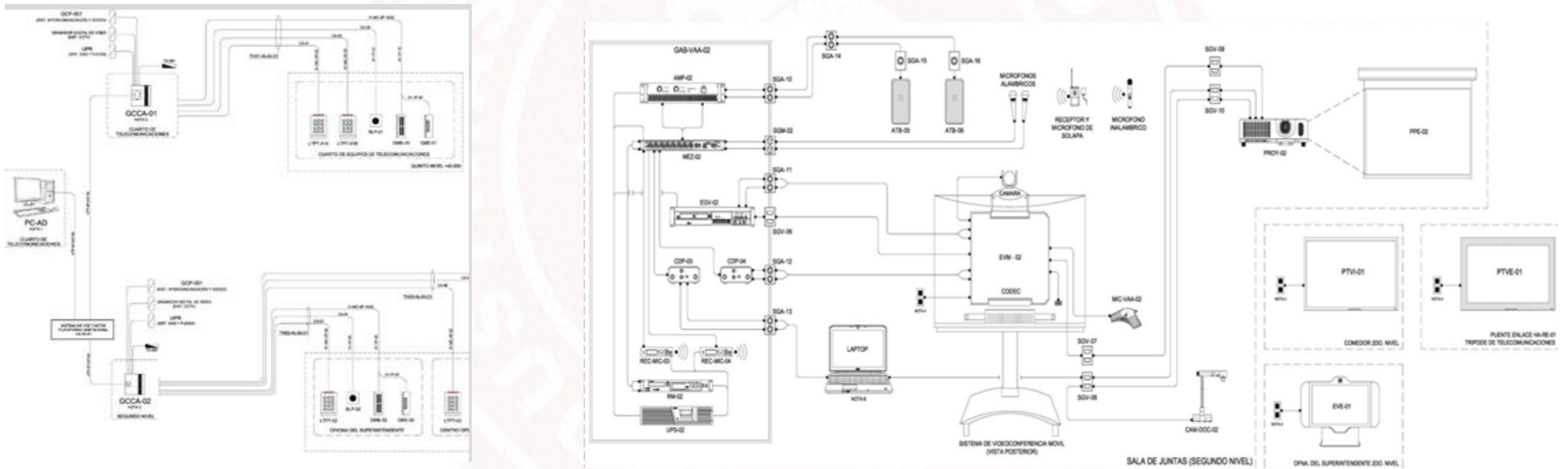

STRUCTURAL WELDING

Structural and Architectural maintenance because we have **Certified welders** by **ASME** boiler and pressure vessel Code Section IX **2015** Y **AWS D1 2105** Structural Welding Code Steel.





OUR EXPERIENCE IN DIVING BUSINESS INCLUDING RESCUE RECOVERY

- **LAYING UNDERWATER LINES.**
- **CHANGE OF ZINC ANODES.**
- **PIPELINE INSTALLATION AND BRACKETS.**
- **MAINTENANCE MONOBUOYS.**
- **INSPECTION Nondestructive Testing (PND).**



Fiber Optic and Structured Cabling

- **We are committed to providing the most innovative** Solutions and expert systems integration for all
- **Aspects of optical transport systems.**
- Fiber Optic Services provides craftsmen and equipment to support all phases of technical services required to successfully deploy an optical transport system. From a “single burn” NID splice to “cutting-over” an entire Central Office in a hot maintenance window, FOS has the experience and expertise to complete the job successfully. Our current services are as follows.
- Fiber Optic Services supplies technical services to fiber optic users primarily for Telecommunications, CATV, Power Utility, FTTP and Cellular Back-haul applications. providing engineering & design assistance, fusion splicing, connectorization, system documentation & characterization, systems integration, FTTx construction, provisioning & cut-over, inside wiring installations (for SFU, MDU, MTU & SMB), “Hot-Cut” splicing and emergency restorations.
- **Our commitment to provide services exclusively for fiber optic systems has allowed us to focus on that specific customer need.**
- Our ability to supply customers with a wide range of "In House" services not available from many single sources makes us unique within the industry.

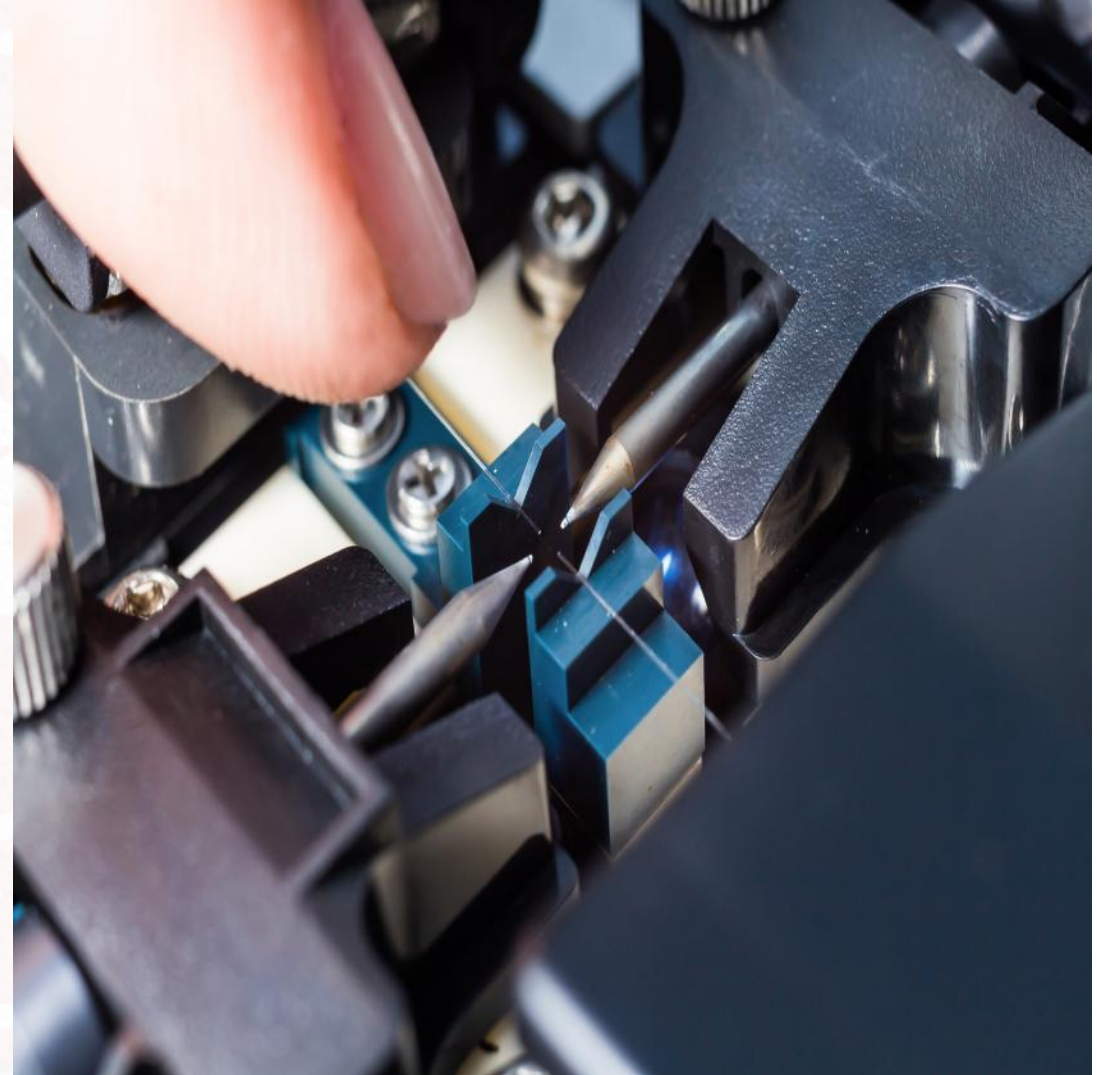

Clients and Projects

Client	Project
PEMEX EXPLORACIÓN Y PRODUCCIÓN	Supply, installation and operation of the bypass system control boards 7 wells brand W-Industries, installed on PP-Ku-C y PP-Ku-S, Maloob-A y Maloob-B, Zaap-A, Zaap-B y Zaap-D Platforms.
SWECOMEX	Supply Interconnect and Well Assembly Control Board Hydroneumatic. :Maloob-A and Maloob-B Platform
BOSNOR, S.A. DE C.V.	Integrated testing site (OSAT) Documentation and put into operation complete and comprehensive system of Dashboards and Well Safety : PP-Ku-C Platform
PEMEX EXPLORACIÓN Y PRODUCCIÓN	Supply and installation of Interface Boards with PLC S7-400, mca. W-industries, from:Abkatun-B, ABK-f and Caan-C, the Integral Pol-Chuc
SIEMENS	Supply Board Hydroneumatic Safety and Well Control Siemens /Commsa. Sinan C Platform

Client	Draft
SIEMENS	Supply Board Hydroneumatic Safety and Well Control Siemens /Commsa. Sinan D Platform
COMMSA (PLANTA TAMPICO)	Supply Board Hydroneumatic Safety and Well Control Siemens /Commsa. Sinan C Platform
COMMSA (PLANTA TAMPICO)	Supply Board Hydroneumatic Safety and Well Control Siemens /Commsa. Sinan D Platform
COMMSA (PLANTA VERACRUZ)	Supply and Presentation Board yard Hydroneumatic Safety and Well Control. Sinan-A Platform
COMMSA (PLANTA VERACRUZ)	Supply and Presentation Board yard Hydroneumatic Safety and Well Control. Sinan-B Platform



Clients and Projects

Client	Draft
COMMSA (PLANTA TAMPICO)	Supply, interconnection and Dashboard Mounting Hydroneumatic Safety and Well Control (TC-1904). :Sihil-A Platform
COMMSA (PLANTA TAMPICO)	Supply Interconnect and Assembly Board Hydroneumatic Safety and Well Control (TC-1904) Akal-W.
COMMSA (PLANTA TAMPICO)	Supply and installation hydropneumatic Interconnection board Safety and Well Control (TC-1904) Akal-Q
CONSTRUCCIONES Y EQUIPOS LATINOAMERICANOS, S.A. DE C.V. (CELASA)	Supply Interconnect and Assembly Control Board Hydroneumatic Pozos (tc-1050): Mision-A Platform
CONSTRUCCIONES Y EQUIPOS LATINOAMERICANOS, S.A. DE C.V. (CELASA)	Supply Interconnect and Assembly Control Board Hydroneumatic Pozos (tc-1904): PP-Lum-A Platform
SWECOMEX	Supply Interconnect and Well Assembly Control Board Hydroneumatic:Sinan-So Platform

Client	Draft
FMC TECHNOLOGIES MÉXICO	4 Supply Control Boards Hydroneumatic Submarines Pozos. Ak-TM, AK-MB, AK-YJ, AK-BN
FMC TECHNOLOGIES MÉXICO	4 boards Hydroneumatic supply Bypass for Well Control Submarines.
PEMEX EXPLORACIÓN Y PRODUCCIÓN	12 Supply Modules for Retrofit Well Control Panels, Control wells in Active Boards Ku-Ma-Zaap
PEMEX EXPLORACIÓN Y PRODUCCIÓN	Conversion board 18 to 12 and 6 wells brand W-Industries, includes Board Interface Integral Ku-Maloob- Zaap.
COMMSA (PLANTA TAMPICO)	Supply Interconnection, Installation and commissioning of Board Hydroneumatic Safety and Control Valve (TCV-1904) Maloob:-D



HEALTH, SAFETY AND ENVIRONMENTAL PROTECTION:

IWM maintains high standards of HSE AND ENVIRONMENTAL PROTECTION

- We have procedures Working on Health, Safety and Environment.
- First AIDS manual.
- Risk Atlas
 - ✓ Customer satisfaction is our main goal.
 - ✓ The staff that makes up our company is our most valuable resource.
 - ✓ We want a long working time with customers and suppliers.
 - ✓ We maintain a permanent ethics and professionalism.



INDUSTRIAS W DE MEXICO SA DE CV

AV. DEL MAR # 46, BIBALVO CD. DEL CARMEN,
CAMPECHE, MEXICO CP 24158

tels. +52 (938) 118-2906, 118-2914, 118-2631, 118-2913

Cel 52-981-166-1765

info@industriaswmexico.com

www.industriaswmexico.com

